

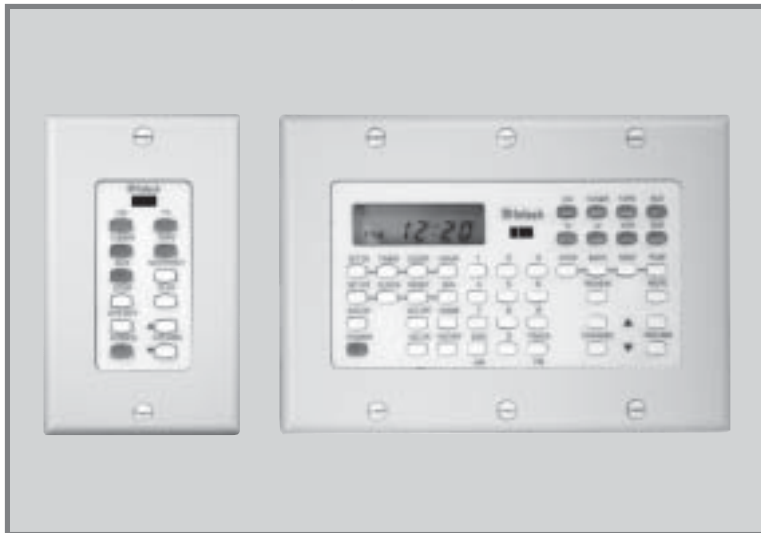

Keypads



WK-3/WK-4 Owner's Manual

McIntosh Laboratory, Inc. 2 Chambers Street Binghamton, New York 13903 2699
Phone: 607 723 3512 FAX: 607 724 0549

McIntosh

The lightning flash with arrowhead, within an equilateral triangle, is intended to alert the user to the presence of uninsulated “dangerous voltage” within the product’s enclosure that may be of sufficient magnitude to constitute a risk of electric shock to persons.



AVIS RISQUE DE CHOC ELECTRIQUE - NE PAS OUVRIR.

The exclamation point within an equilateral triangle is intended to alert the user to the presence of important operating and maintenance (servicing) instructions in the literature accompanying the appliance.

WARNING - TO REDUCE RISK OF FIRE OR ELECTRICAL SHOCK, DO NOT EXPOSE THIS EQUIPMENT TO RAIN OR MOISTURE.

NO USER-SERVICEABLE PARTS INSIDE. REFER SERVICING TO QUALIFIED PERSONNEL.

To prevent the risk of electric shock, do not remove cover or back. No user serviceable parts inside.

IMPORTANT SAFETY INSTRUCTIONS!

PLEASE READ THEM BEFORE OPERATING THIS EQUIPMENT.

1. Read these instructions.
2. Keep these instructions.
3. Heed all warnings.
4. Follow all instructions.
5. Do not use this apparatus near water.
6. Clean only with a dry cloth.
7. Do not block any ventilation openings. Install in accordance with the manufacturer’s instructions.
8. Do not install near any heat sources such as radiators, heat registers, stoves, or other apparatus (including amplifiers) that produce heat.
9. Do not defeat the safety purpose

of the polarized or grounding-type plug. A polarized plug has two blades with one wider than the other. A grounding type plug has two blades and a third grounding prong. The wide blade or the third prong are provided for your safety. If the provided plug does not fit into your outlet, consult an electrician for replacement of the obsolete outlet.

10. Protect the power cord from being walked on or pinched particularly at plugs, convenience receptacles, and the point where they exit from the apparatus.
11. Only use attachments/accessories specified by the manufacturer.
12. Use only with the cart, stand, tripod, bracket, or table specified by the manufacturer, or sold with the apparatus.



When a cart is used, use caution when moving the cart/apparatus combination to avoid injury from tip-over.

13. Unplug this apparatus during lightning storms or when unused for long periods of time.
14. Refer all servicing to qualified service personnel. Servicing is required when the apparatus has been damaged in any way, such as power-supply cord or plug is damaged, liquid has been spilled or objects have fallen into the apparatus, the apparatus has been exposed to rain or moisture, does not operate normally, or has been dropped.
15. Do not expose this equipment to dripping or splashing and ensure that no objects filled with liquids, such as vases, are placed on the equipment.
16. To completely disconnect this equipment from the a.c. mains, disconnect the power supply cord plug from the a.c. receptacle.
17. The mains plug of the power supply cord shall remain readily operable.

Thank You

Thank you for your decision to own this McIntosh WK-3 or WK-4 Keypad. The McIntosh dedication to "Quality" is assurance that it will provide you with many years of enjoyment.

Please take time to read this manual, as it will help you to become more familiar with your new McIntosh Keypad.

Please Take A Moment

The serial number, purchase date and dealer name are important for possible insurance claim or future service. The spaces below have been provided to record that information:

Serial Number: _____

Purchase Date: _____

Dealer Name: _____

Technical Assistance

If you have questions about this product, contact your McIntosh Dealer who is more familiar with your component system. If additional help is needed, you can receive technical assistance at:

McIntosh Laboratory, Inc.
2 Chambers Street
Binghamton, New York 13903
Phone: 607-723-3512
Fax: 607-723-3636

McIntosh

Customer Service

If your McIntosh product is in need of repair, it can be returned to your Dealer or the McIntosh Service Department. For assistance on repair return procedure, contact the McIntosh Service Department at:

McIntosh Laboratory, Inc.
 2 Chambers Street
 Binghamton, New York 13903
 Phone: 607-723-3515
 Fax: 607-723-1917

Table of Contents

Safety Instructions	2
Thank You	3
Please Take a Moment	3
Customer Service	4
Table of Contents	4
Important Information	4
Connector Information	5
Introduction	6
Performance Features	6
WK-3 Installation and Dimensions	7
WK-4 Installation and Dimensions	8
How to Connect with the 5-Pin Terminal Connector	9
How to Connect with the RJ45 Connector	10
WK-3 Front Panel Push-Buttons	11
WK-4 Front Panel Display and Push-Buttons	12
How to Operate the WK-3 and WK-4 .	13
Specifications	15
Packing Instruction	15

Important Information

1. *Before connecting the WK 3/WK 4 Keypads to a McIntosh A/V Control Center, Multizone Controller or Preamplifier make sure that the Main POWER Switch on those units are in the Off position or unplug the AC Power Cord from the wall outlet. When those units are in their Standby Mode the Microprocessor's Circuitry inside each component is active and communication is occurring between them. Failure to do so could result in malfunctioning of some or all of the system's normal operations including the keypads.*
2. *Connector is available from the McIntosh Parts Department:*
Terminal Block Plug with five Connections Part No. 117-672
3. *For additional connection information, refer to the owner's manual(s) for any component(s) connected to the WK3/WK4 Keypad.*
4. *Up to four McIntosh Keypads or (Sensors) can be wired in parallel for each Remote Zone.*
5. *A McIntosh WK 3/WK 4 Keypad may be connected to earlier McIntosh A/V Control Centers, Multizone Controllers or Preamplifiers that uses a "F" Coax Connector instead of the Terminal Block Socket. It does require the addition of a 12VDC Power Supply for proper operation. Follow the hookup connections below:*

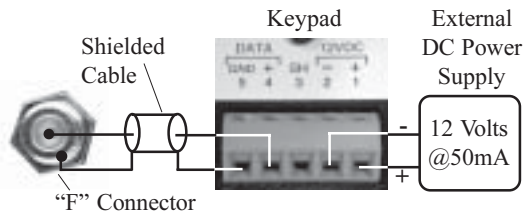

6. The WK 3/WK 4 Keypads are designed to be connected with a "four conductor shielded cable" or "CAT 5 shielded cable". In most installations a non shielded cable may be used with the WK 3/WK 4, however the shielded cable provides the best immunity from outside interference.
7. The DVD Source Selection Push button on the WK 3 and WK 4 Keypads is labeled as V AUX on earlier McIntosh A/V Control Centers, Multizone Controllers and Preamplifiers.
8. The last production versions of the MX130 (serial number starts with ND1001) and the C39 (serial number starts with NC1001) utilize a single terminal block socket with connections for both Zone A and Zone B.

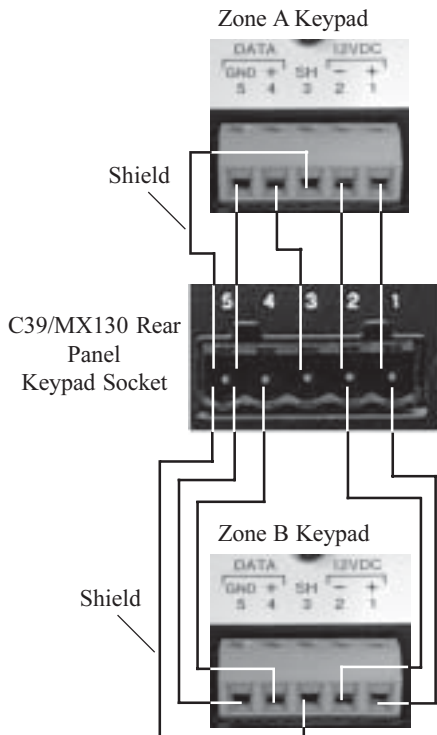

Connector Information

RJ45 Keypad Terminal Connector

When connecting the WK-3/WK-4 Keypad with McIntosh A/V Control Centers, Multizone Controller or Preamplifier utilizing a RJ-45 Connector Socket connect as follows:

RJ-45 Socket

1. Signal Data
2. Signal Data Gnd. and Cable Shield
3. N/C
4. Supply Voltage Negative
5. Supply Voltage Positive
6. N/C
7. N/C
8. N/C

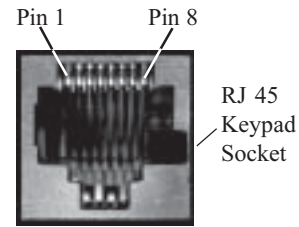

5 Pin Keypad Terminal Connector

When connecting the WK-3/WK-4 Keypad with McIntosh A/V Control Centers, Multizone Controller or Preamplifier utilizing a 5 Pin Terminal Block Connector Socket and Plug connect as follows:

1. Supply Voltage Positive
2. Supply Voltage Negative
3. Cable Shield
4. Signal Data
5. Signal Data Ground

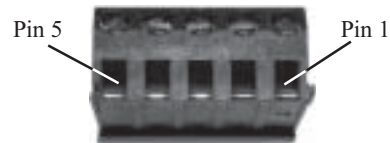

Introduction

The McIntosh WK-3 and WK-4 keypads allow convenient push-button remote control of McIntosh A/V Control Centers, Multizone Controller and Preamplifiers.

WK-3 and WK-4 Performance Features

- **Built-in IR sensor**

Adds the convenience of operating a component with a remote control in a local zone.

- **Multiple Inputs**

Select any available audio/video source in a local zone.

- **Local Volume Control**

Adjust local zone volume level up or down.

- **Illuminated Push-Buttons**

Input and power push-buttons illuminate to indicate zone status and selected signal source.

- **Transport Controls**

Perform operating functions on Disc Players or tape recorders.

- **Wake-up Source and Volume**

Select the signal source and volume level that is active when a zone is turned on.

- **Power Off of Local Zone and System**

Turn off a local zone, or turn off the entire system.

- **Integrates with the Remote Control Translator**

The Keypads work together with a McIntosh Remote Control Translator to provide remote operation of non McIntosh Source components without the bother and expense of multiple Universal Remote Controls.

WK-4 Performance Features

- **Built-in Clock and Timer**

The clock display indicates the time of day, as well as the on and off set times of special events.

- **Preset Timed Events**

Enjoy listening to a signal source for a specific time using the timed event turn on and turn off feature.

- **Sleep Mode**

Set a turn off or sleep time in 10 minute intervals up to one hour.

WK-3 Dimension and Installation

WK-3 Dimension and Installation

The WK-3 can be custom installed in a wall opening, piece of furniture or cabinet of your choice. The WK-3 will fit in a standard NEMA, 1-gang, sheet-steel or non-metallic outlet box with a depth of 2-1/2 inches. The WK-3 can be mounted directly to a wood or plasterboard wall by making a cutout according to the dimensions shown below. Plastic screw anchors are supplied for installation in plasterboard. Make sure the mounting surface is flat so the keypad does not bend or deform as the screws are tightened. Do not install the WK-3 directly above a heat generating object such as a radiator.

Note: Allow for an additional 1/8 of an inch (3.2mm) in depth behind the Terminal Connector for wires.

**WK-3
Bottom View**

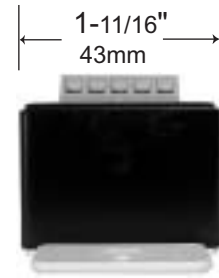

**WK-3
Side View**

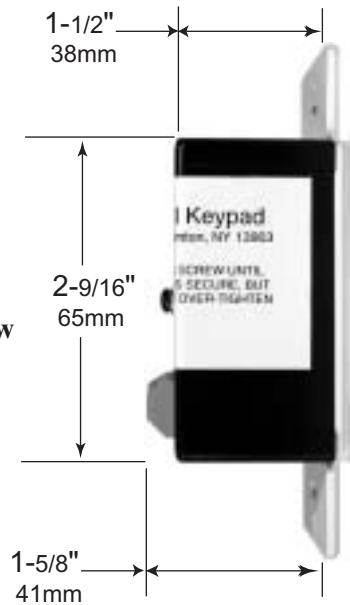

**WK-3
Mounting
Cutout Detail**

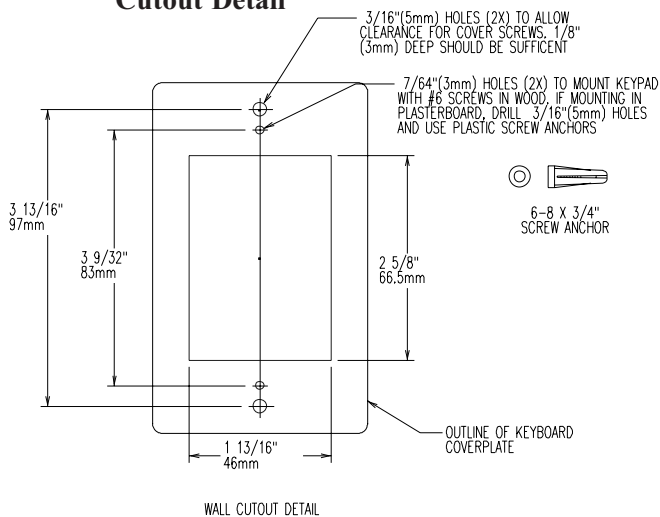

McIntosh

WK-4 Dimension and Installation

WK-4 Dimension and Installation

The WK-4 can be custom installed in a wall opening, piece of furniture or cabinet of your choice. The WK-4 will fit in a standard NEMA, 3-gang, sheet-steel or non-metallic outlet box with a depth of 2-1/2 inches. The WK-4 can be mounted directly to a wood or plasterboard wall by making a cutout according to the dimensions shown below. Plastic screw anchors are supplied for installation in plasterboard. Make sure the mounting surface is flat so the keypad does not bend or deform when the screws are tightened. Do not install the WK-4 directly above a heat generating object such as a radiator.

Note: Allow for an additional 1/8 of an inch (3.2mm) in depth behind the Terminal Connector for wires.

WK-4 Bottom View

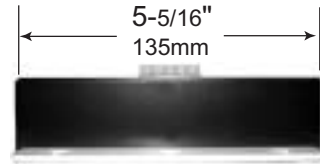

WK-4 Side View



WK-4 Mounting Cutout Detail

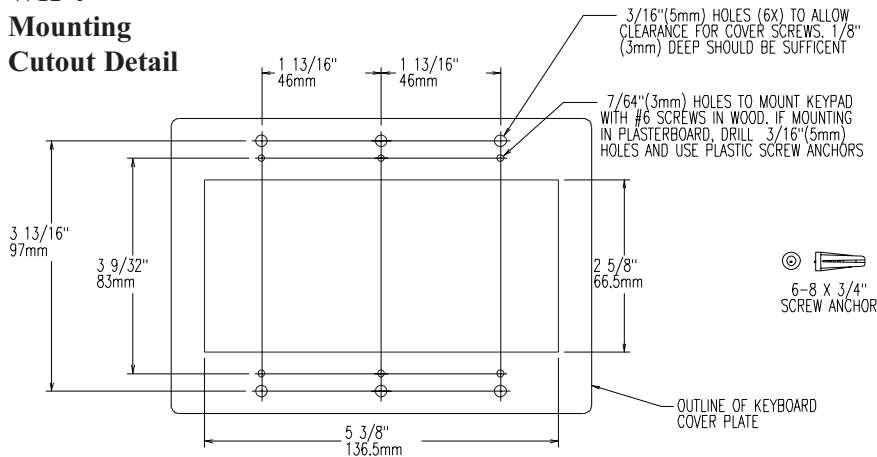

WALL CUTOUT DETAIL

How to Connect with the 5-Pin Terminal Connector

How to Connect with the 5-Pin Terminal Connector

1. Connect one end of a shielded 4 conductor cable from the WK-4 Keypad Connector to the 5-Pin Terminal Connector Plug, refer to adjacent chart along with pages 4 and 5 of this manual. Connect the 5-Pin Terminal Connector Plug to the Zone 1 5-Pin Terminal Block Connector of the McIntosh System Controller.

Note: Refer to "Important Information" number 5 and 8 on page 5 when connecting the keypads to a C39 or MX130. If the Keypad is used in the same room as the System Controller, it is important to disable the Front Panel Sensor on the Controller to prevent

interference. Refer to the System Controller Owner's Manual for additional information.

2. Connect the WK-3 Keypad in a similar manner as above except connect the 5-Pin Terminal Connector Plug to the Zone 2 5-Pin Terminal Block Connector of the McIntosh System Controller.

Keypad Connections		
Keypad Connection Number	5-Pin Plug Connection Number	Wire Color
1	1	
2	2	
3	3	
4	4	
5	5	



McIntosh System Controller

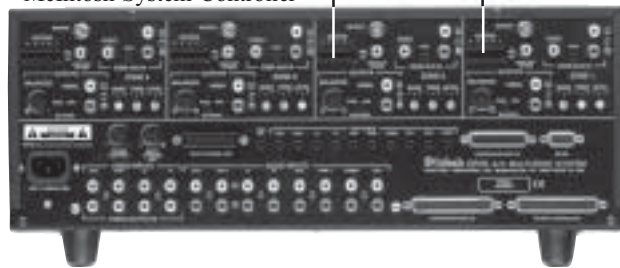

How to Connect with the RJ45 Connector

1. Connect one end of a shielded 4 conductor cable from the WK-3 Keypad Connector to the RJ45 Connector Plug, refer to adjacent chart along with page 5 of this manual. Connect the RJ45 Plug to the Zone A RJ45 socket of the McIntosh A/V Controller.

Note: If the Keypad is used in the same room as the System Controller, it is important to disable the Front Panel Sensor on the Controller to prevent interference. Refer to the A/V Controller Owner's Manual for additional information.

2. Connect the WK-4 Keypad in a similar manner as above except connect the RJ45 Plug to the Zone B RJ45 Socket of the McIntosh A/V Controller.

Keypad Connections		
Keypad Connection Number	RJ45 Plug Connection Number	Wire Color
1	5	
2	4	
3	2	
4	1	
5	2	

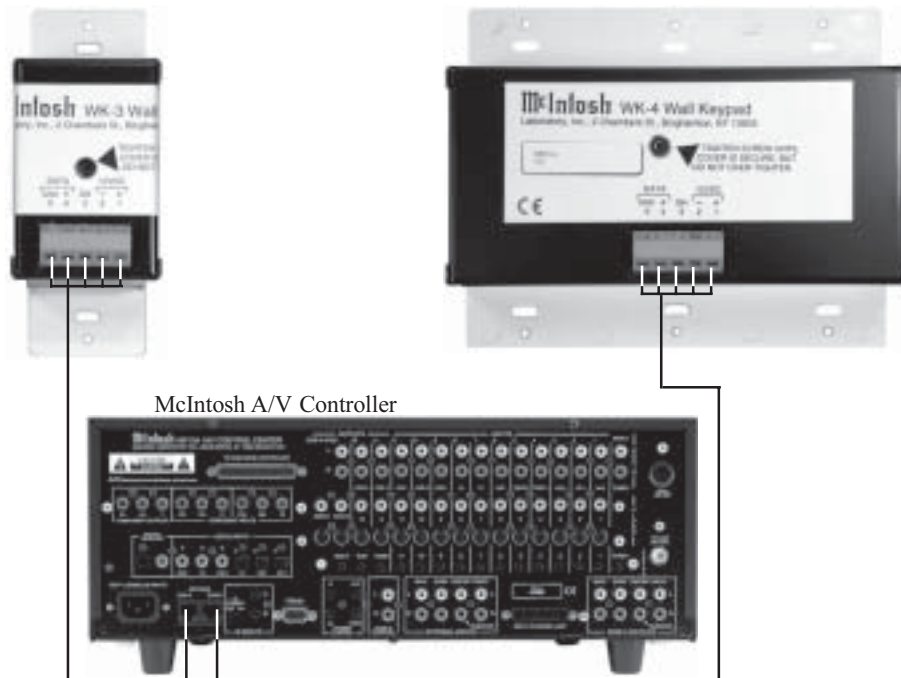

WK-3 Front Panel Push-Buttons

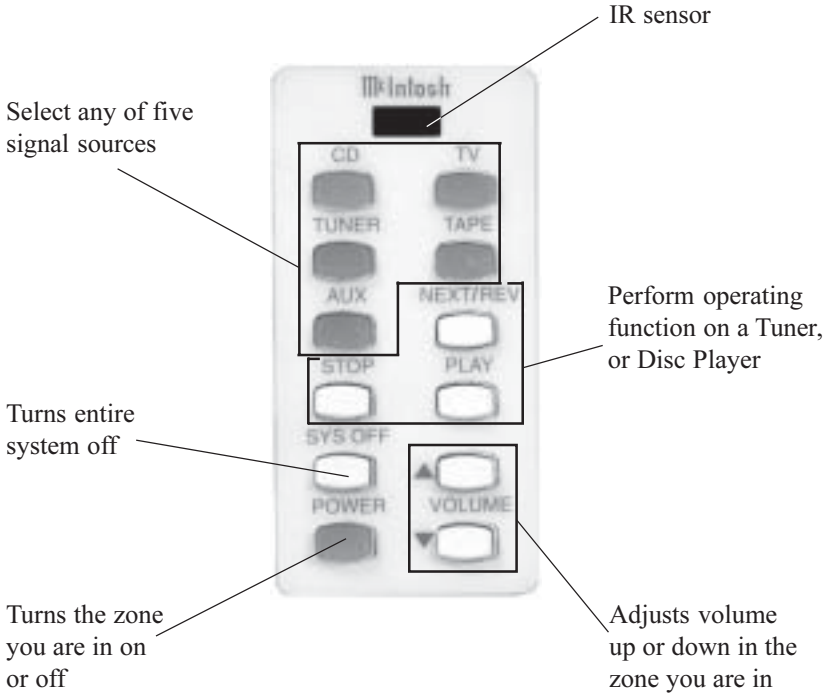

McIntosh

WK-4 Front Panel Display and Push-Buttons

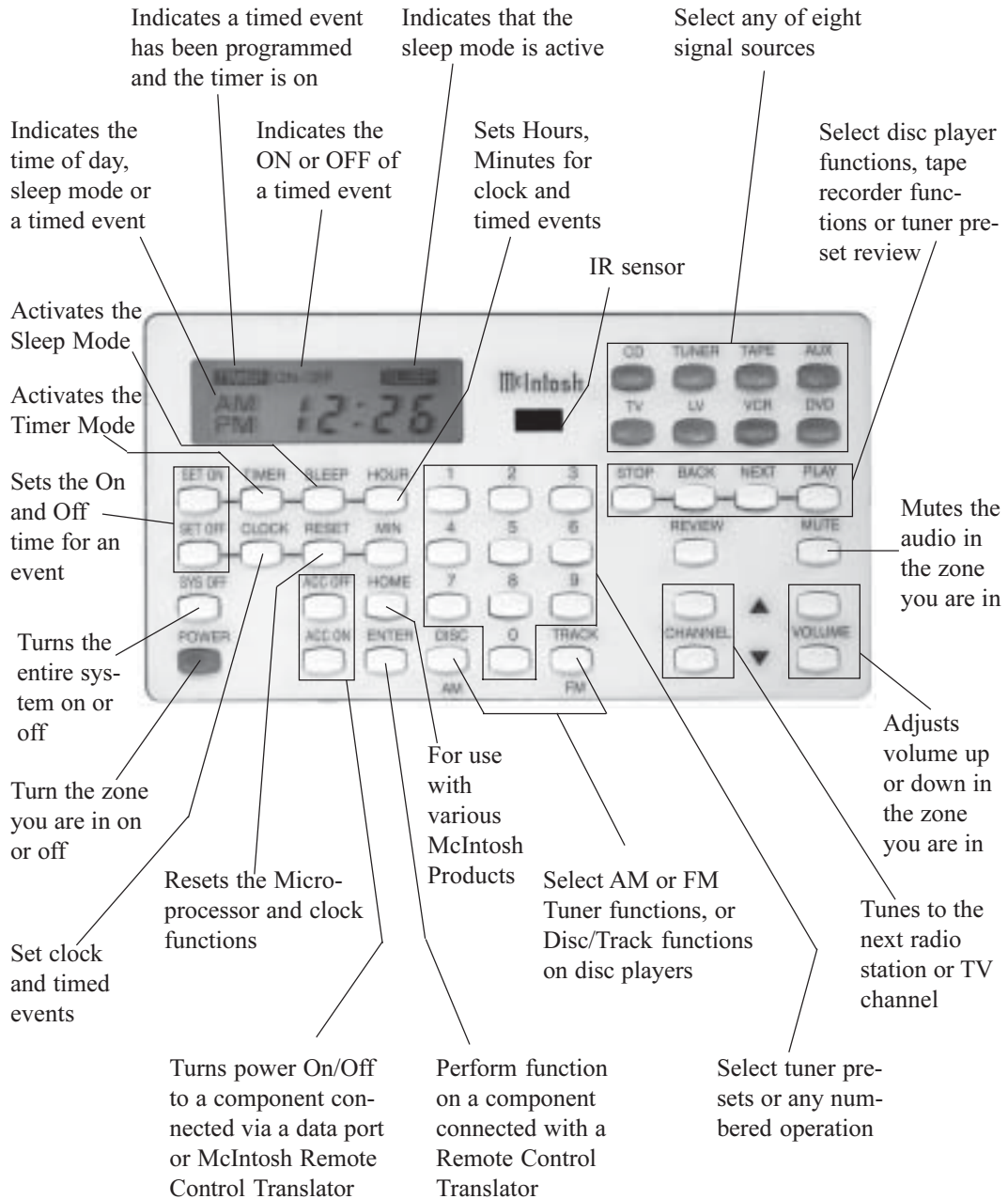

How to Operate the WK-3 and WK4

How to Operate the WK-3 and WK-4

Input Push-buttons

Press to turn on a local zone and select a desired signal source. The selected source push-button will illuminate.

Note: Refer to page 11 for the WK 3 and page 12 for the Wk 4.

Transport Operations

Press Play, Stop or Next (next track)/Rev to operate a disc player or tape recorder.

Tuner Operations

When a McIntosh tuner is being used, press Next/Rev (Review) to cycle through the tuner presets.

System Off

Press the Sys Off Push-button to turn off the entire system including the local zone.

Power

Press the Power push-button to turn On or Off the local zone.

Note: When a zone is muted the Power push button blinks on and off to indicate muting is active.

Volume

Press an up or down Volume push-button to raise or lower the volume in the local zone.

IR Sensor

Aim a Remote Control toward the built-in sensor to perform operating functions.

WK-4 Additional Functions

Mute

Press the Mute push-button to mute audio in the local zone. The Power push-button will blink on and off to indicate muting is active. Press again to unmute.

0-9 Numbered Push-buttons

Press a number push-button to select tracks on a Disc Player, Tuner Presets or any numbered operation.

Tuner operations

Press AM or FM to select the desired broadcast band. Press Channel up or down to tune up or down the broadcast band. Press Review to cycle through the tuner presets.

Transport Operations

Press Stop, Back (backtrack), Next (next track) or play to operate a disc player or tape recorder. Press Acc On push-button to turn AC power of certain a McIntosh Disc Players on and off.

Disc and Track

The Disc (AM) and Track (FM) push-buttons to operate on disc players.

Reset Push-Button

The RESET push-button is used to perform the following:

1. Press and hold for 3 seconds or more to reset ALL CLOCK functions to zero.
2. Press momentarily to reset the WK-4 microprocessors in case of lockup.

Note: This condition is usually caused by either interruptions in AC power and/or major changes in voltage.

How To Set the Keypad Clock Time

Press and Hold the Clock push-button for the entire time setting procedure:

1. Press and Hold the Hours push-button until the display indicates the correct AM or PM hour.
2. Press and Hold the Minutes push-button until the display indicates the correct minute.
3. Release the Clock push-button.

Note: If you wish to cancel the clock setting and start over, press RESET and hold for 3 seconds or more.

How To Set Sleep Time

Sleep times can be set from a minimum of 10 minutes to a maximum of 60 minutes, in 10 minute intervals.

1. Press the Sleep push-button once. The display will read 60 minutes and the zone will turn on. By pressing the Sleep push-button again (within 3 seconds) the display will indicate an additional time reduction of 10 minutes for each press.
2. When the desired Sleep time is reached the Sleep indicator on the display will turn on and the clock will return to the normal time display. The system will stay on with the last source selected for the set time and then turn off.
3. If at any time you wish to cancel the

Sleep function, press Sleep again. The zone will now turn off.

How To Set a Timed On-Off Event

Press and Hold the Set On push-button for the entire time setting procedure:

Note: The On and Timer indicators on the clock display will turn on.

1. Press and Hold the Hours push-button until the display indicates the desired AM or PM hour.
2. Press and Hold the Minutes push-button until the display indicates the correct minute.
3. Release the Set On push-button, the On and Timer indicators turn off and the starting time is now set.

Press and Hold the Set Off push-button for the entire time setting procedure:

Note: The On and Timer indicators on the clock display will turn on.

4. Press and Hold the Hours push-button until the display indicates the desired AM or PM hour.
5. Press and Hold the Minutes push-button until the display indicates the correct minute.
6. Press the Timer push-button to activate the On/Off timed event function. The TIMER indicator will turn on and the signal source will turn on and off at the set times.

Note: You can turn off the Timer mode by pressing the Timer push button again and the Timer display turns off. All the set on and off times will be retained in memory for later use, or until they are changed.

Specifications and Packing Instructions

WK-3 Specifications

Power Requirements

12 Volts, D.C. @43mA

Dimensions

1-11/16 inches (43 mm) Wide, 2-9/16 inches (65 mm) High, 1-5/8 inches (41 mm) Depth, allow an additional 1/8 of an inch (3.2 mm) for wires

Weight

0.5 pound (0.23 Kg) net, 1 pound (0.45 Kg) shipping

WK-4 Specifications

Power Requirements

12 Volts, D.C. @43mA

Dimensions

5-5/16 inches (135 mm) Wide, 2-9/16 inches (65 mm) High, 1-5/8 inches (41 mm) Depth, allow an additional 1/8 of an inch (3.2 mm) for wires

Weight

1 pounds (0.45 Kg) net, 2 pound (0.9 Kg) shipping

WK-3 and WK-4 Packing Instructions

In the event it is necessary to repack the equipment for shipment, use the original shipping carton and interior parts only if they are all in good serviceable condition. If a shipping carton or any of the interior part(s) are needed, please call or write Customer Service Department of McIntosh Laboratory. Please see the Part List for the correct part numbers.

<u>Quantity</u>	<u>Part Number</u>	<u>Description</u>
1	033922	Shipping carton



McIntosh Laboratory, Inc.
2 Chambers Street
Binghamton, NY 13903

The continuous improvement of its products is the
policy of McIntosh Laboratory Incorporated who
reserve the right to improve design without notice.
Printed in the U.S.A.

McIntosh Part No. 04059101